

MA4820

OUTLINE DIMENSIONS

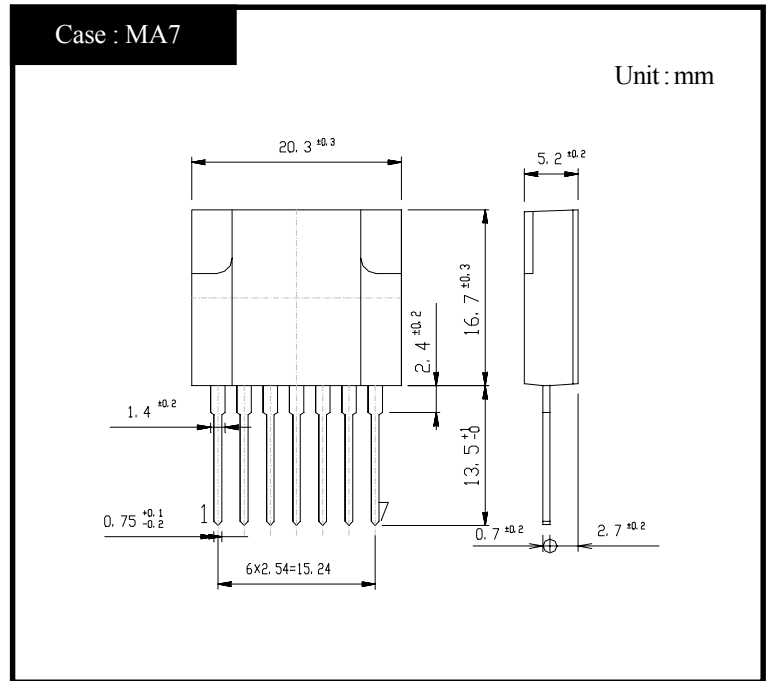

RATINGS

● Absolute Maximum Ratings

Item	Symbol	Conditions	Ratings	Unit
Storage Temperature	Tstg		-30 ~ 125	°C
Operating Temperature	Top		-20 ~ 125	°C
Junction Temperature	Tj		150	°C
Peak Input Voltage	Vin	②+,③-,⑤-	800	V
Input Current	Iin	DC ②+,③-	5	A
		Pulse ②+,③- Duty 1/2	10	A
Maximum Power Dissipation	PD	Ta=25°C	3	W
		Heatsink Tc=100°C	21	W
Dielectric Strength	Vdis	Terminals To Case AC 1 min	2	kV
Insulation Resistance		Terminals To Case 500VDC	100	MΩ
Max Voltage ④ to ⑥	V④•⑥	④+,⑥-	6	V
Max Current ⑥ to ④	I⑥•④	⑥+,④- (Peak) Duty Max 1/2	200	mA
Reverse Current	Iz	⑤+,④-	MAX 20	mA

● Electrical Characteristics (Tc=25°C)

Item	Symbol	Conditions	Ratings	Unit	
Q1	Zero Gate Voltage Drain Current	Idss	VDS=800V, VGS=0V, ②+,③-	MAX 250	μA
	Static Drain-Source On-State Resistance	RDS(on)		TYP (2.1)	Ω
			Ib=2.5A, ②+,③- VGS=10V, ⑤+,③-	MAX 3.0	Ω
D1	Thermal Resistance	θjc	Junction to Case	MAX 2.3	°C/W
Q2	Reverse Current	IR	VGS=800V, ①+,②-	MAX 10	μA
	Forward Voltage	VF	IF=0.6A, ②+,①-	MAX 1.7	V
	Fold Back Detection Voltage		③+,④-	TYP 0.7	V

●Standard Operating Condition•Design Standard For Application Circuit

Item	Conditions	Ratings	Unit
Input Rated Voltage		AC90~276	V
Output Nominal Voltage		12	V
Output Nominal Current		4	A

●Standard Operating Condition•Standard Operating Characteristics (Ta=25°C)

Item	Conditions	Ratings	Unit		
Minimum Input Full Load Output Voltage	Vin=90V, I _O =4.0A	12.0±0.6	V	Fig 1, ① Refer	
Maximum Input Light Load Output Voltage	Vin=276V, I _O =0.40A	12.0±0.6	V	Fig 1, ② Refer	
Over Current Protection	Foldback Current	Vin=276V, V _O =10V	MAX 6.0	A	Fig 1, ③ Refer
	Short Circuit	Vin=276V, R _O =0.5Ω	Nodamage To Any Device, Automatic Recovery.	-	Fig 1, ④ Refer

Figure in ○=Terminal Sign

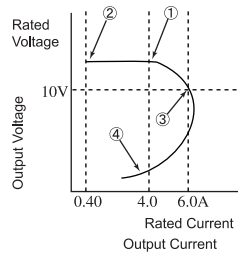
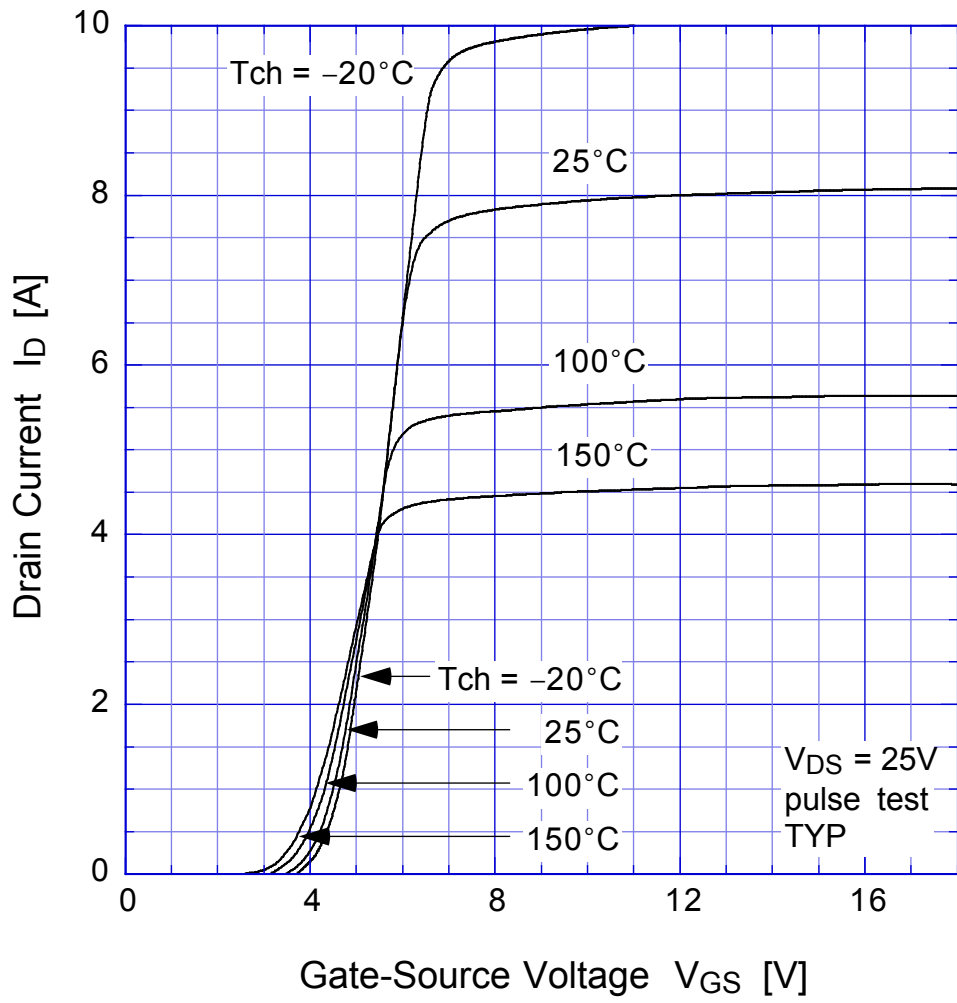

Fig1. Output Voltage/Current

MA4820

Transfer Characteristics



MA4820 Static Drain-Source On-state Resistance

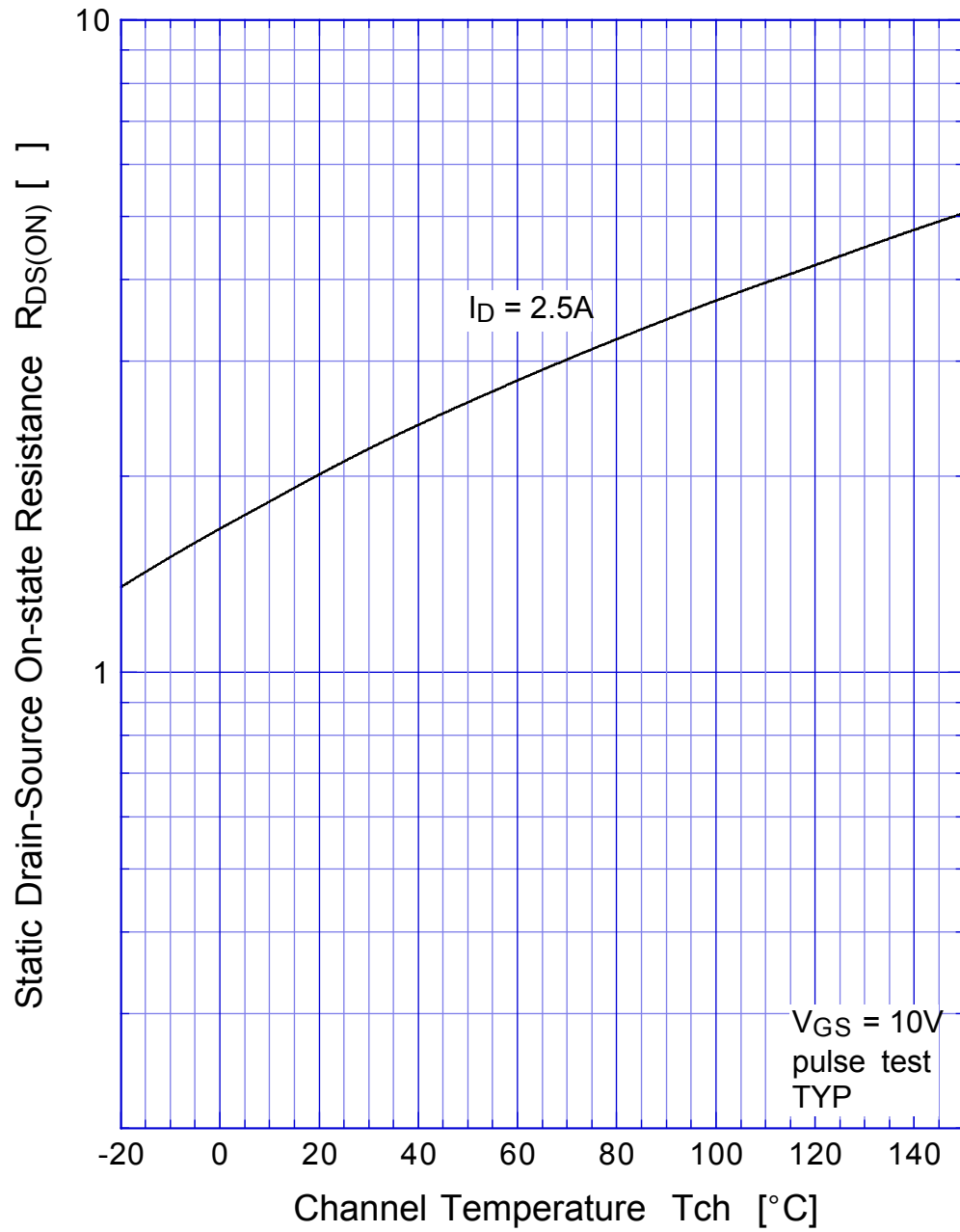

MA4820

Gate Threshold Voltage

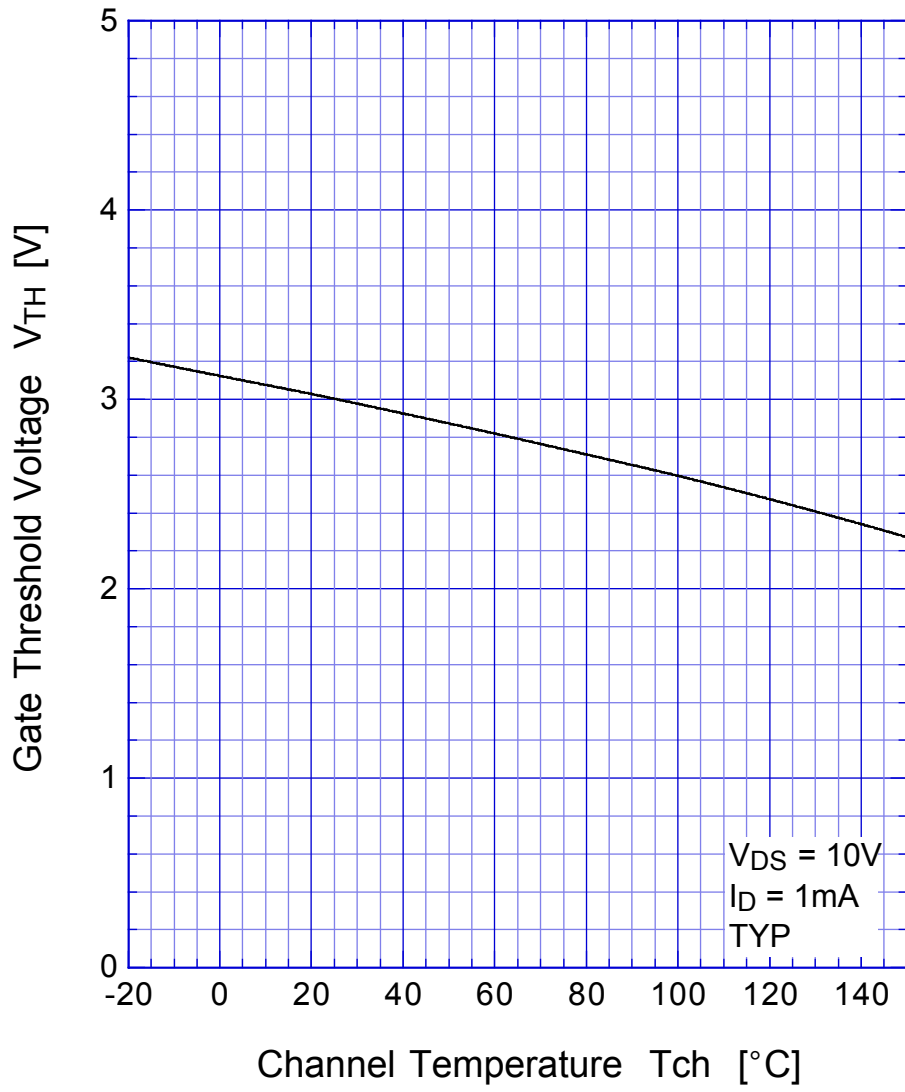

MA4820

Capacitance

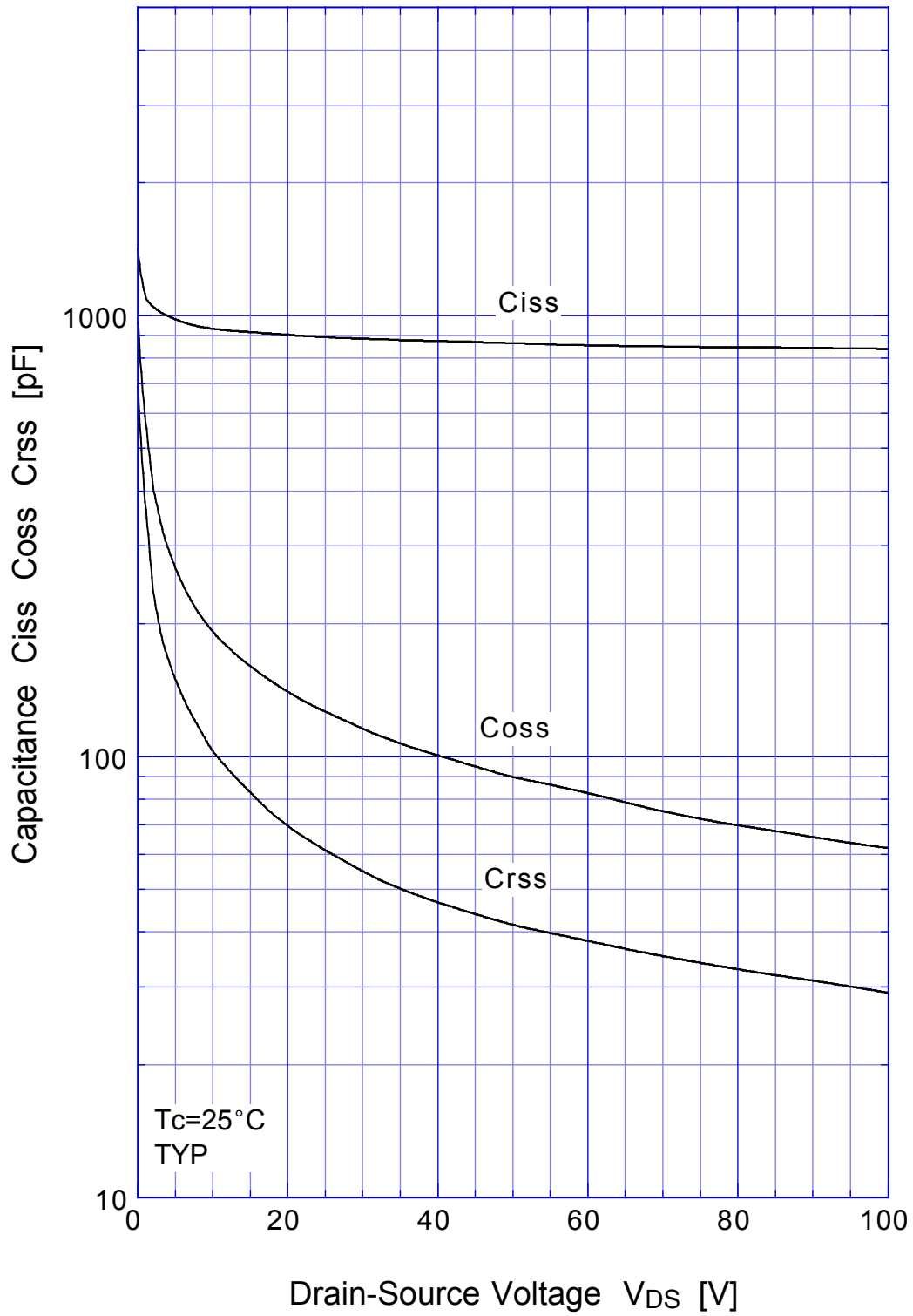

MA4820 Transient Thermal Impedance

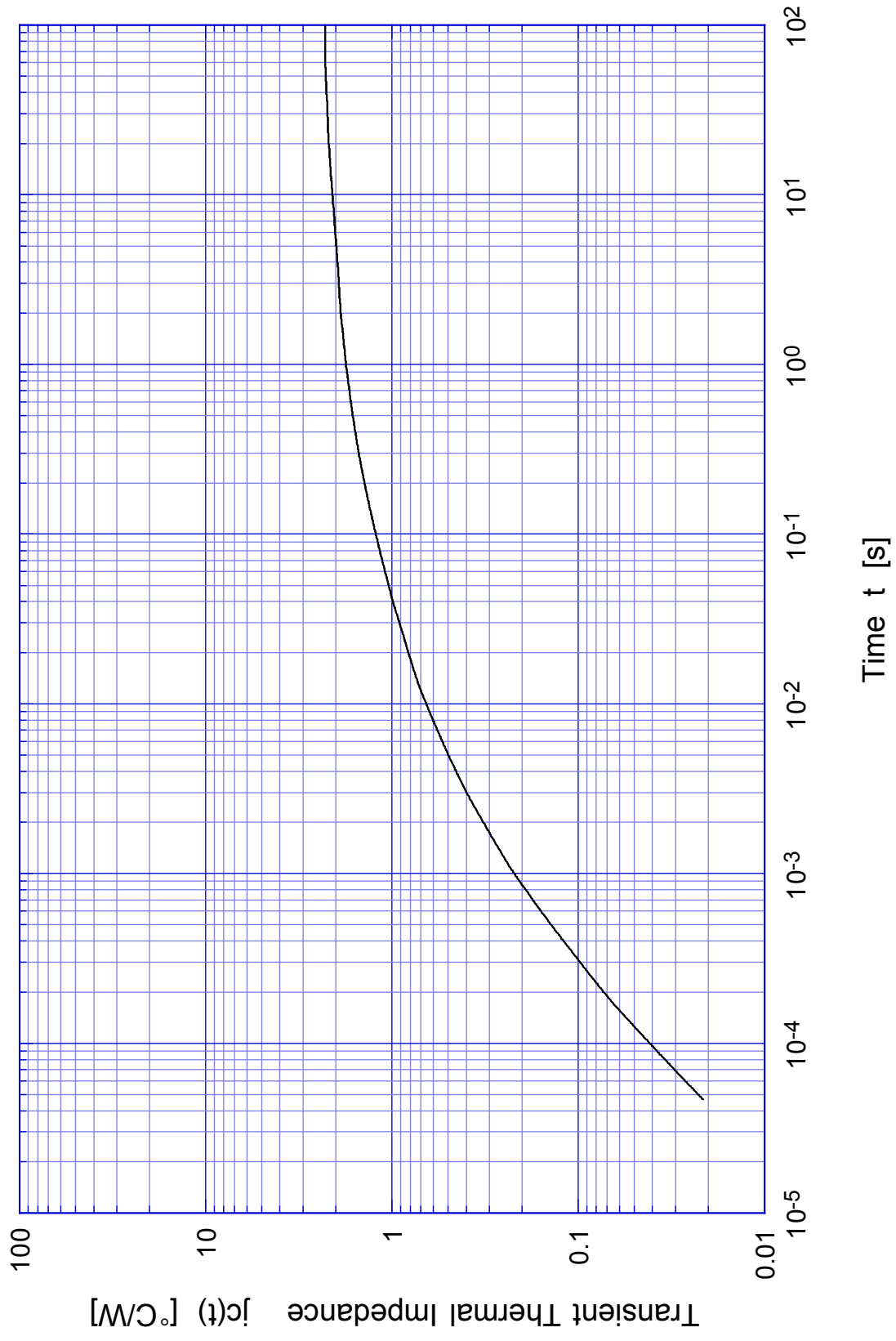

MA4820

Safe Operating Area

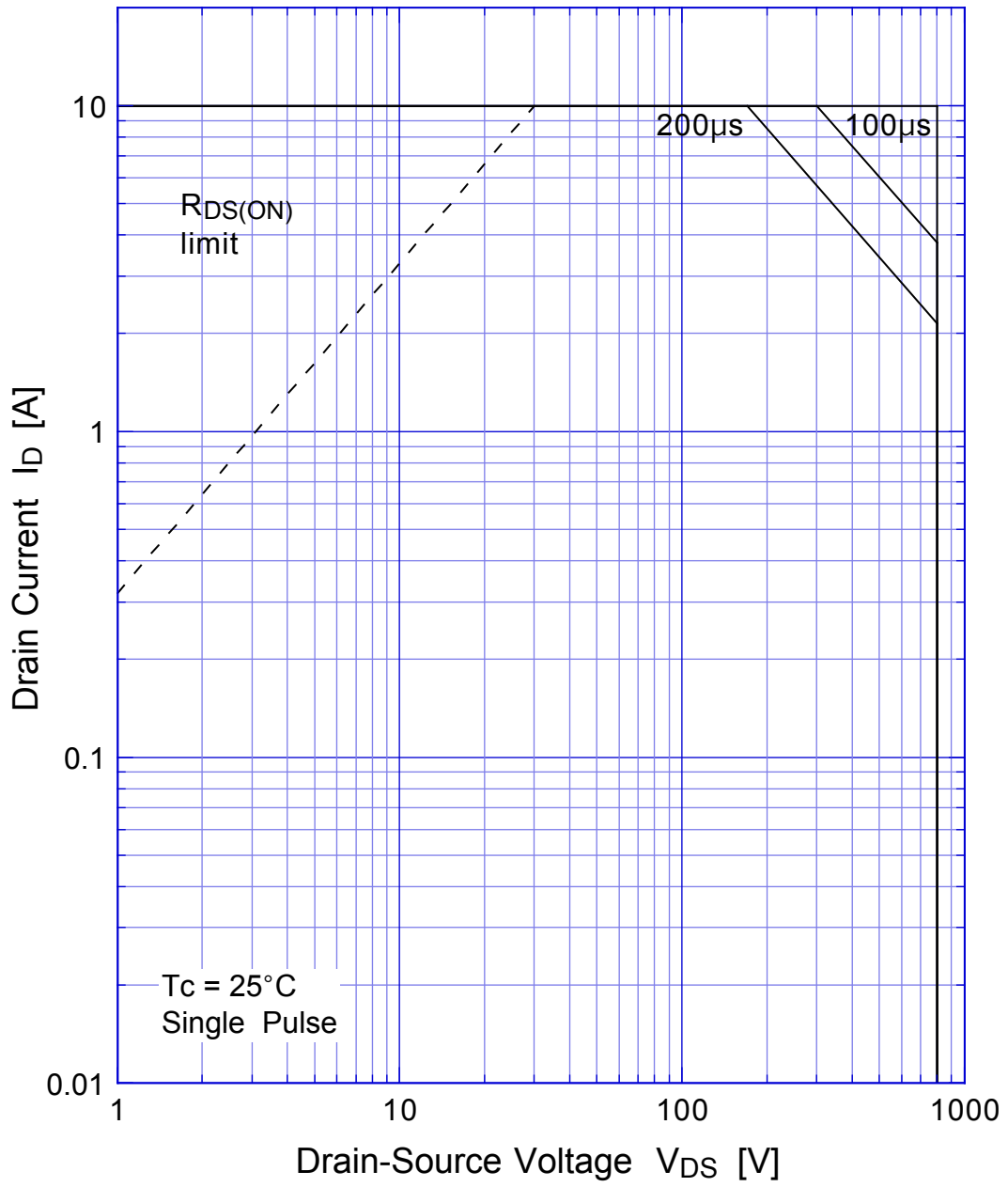

MA4820

Power Derating

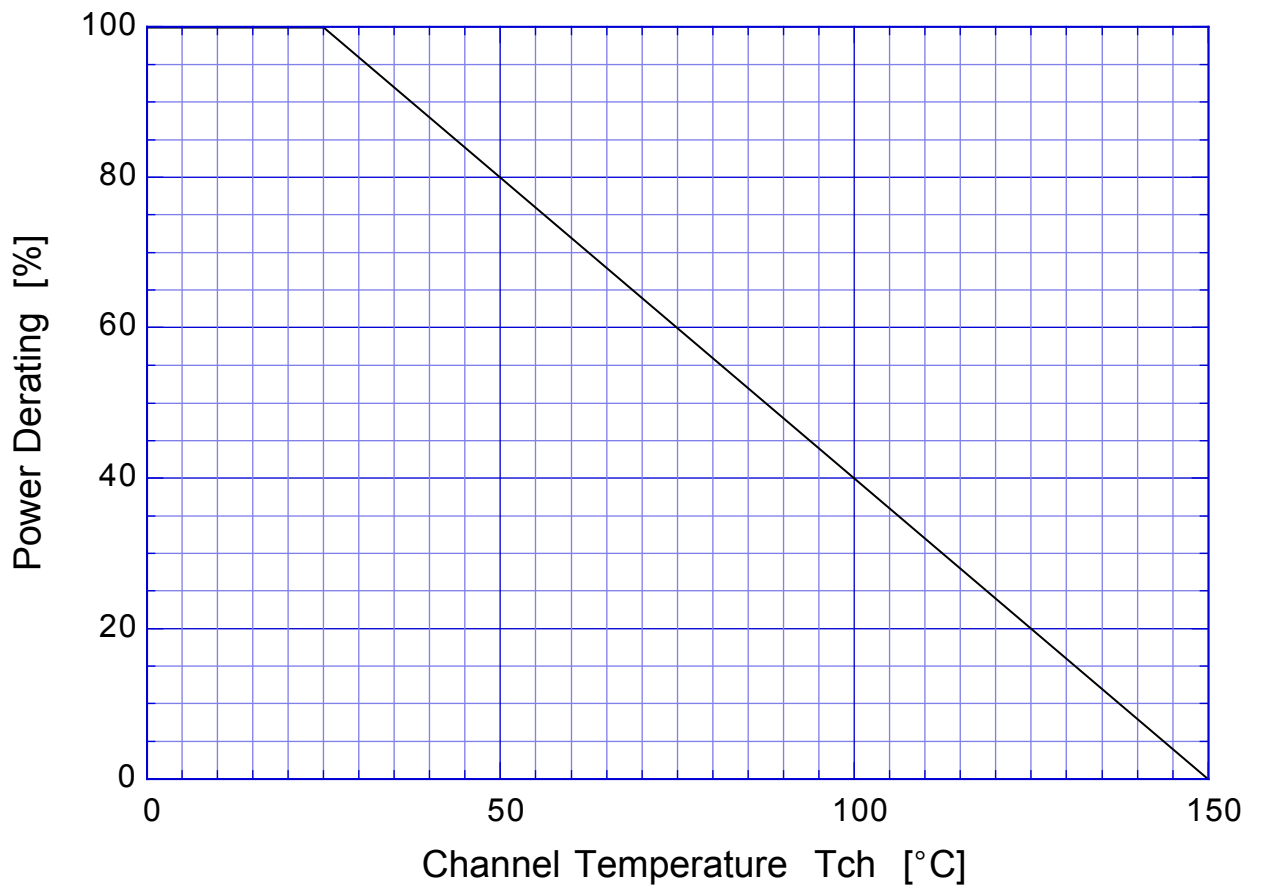

This datasheet has been download from:

www.datasheetcatalog.com

Datasheets for electronics components.